

NEMA14-01

Schematische Zeichnungen

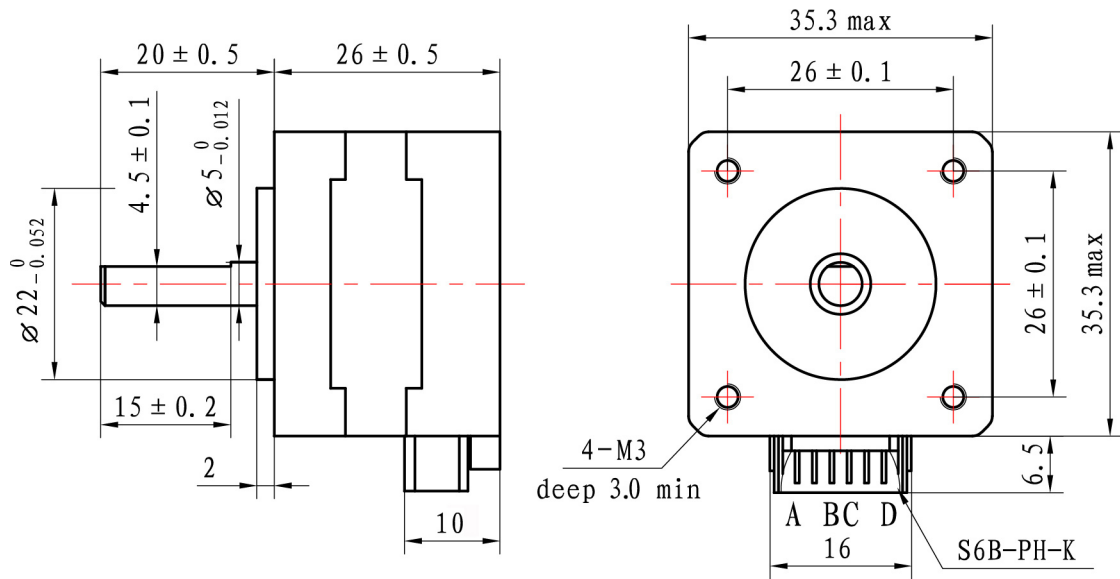

Wiring diagram

