

FLAT NEMA STEPPER

NEMA-FLAT01

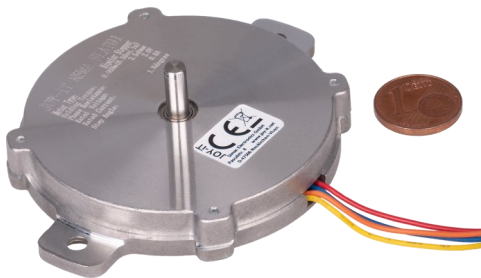

These ultra-flat stepper motors have been specially developed for the feeders in semiconductor production.

But also in other areas with limited space, these flat stepper motors can be used very well.

MAIN FEATURES

Shaft	Ø 4 x 10 mm
Interface connection	4 pin JST cable connector
Special features	ultraslim design
Dimensions	Ø 60 x 9.6 mm
Items delivered	1x NEMA-FLAT01 stepper motor

PERFORMANCE SPECIFICATIONS

Holding torque	60 mNm
Rated Voltage	2.8 V
Rated Current	0.8 A
Step Angle	1.8 ° ±5 %
No. of Phases	2
Phase Resistance	3.5 Ω
Phase inductivity	1.8 mH
Isolation resistance	100 MΩ min. @500 V DC
Isolation class	B (130 °C)
Rotational inertia	15 g·cm ²
Detent Torque	8 mNm
Operating temperature	-10 °C - 50 °C

FURTHER DETAILS

Article No.	NEMA-Flat01
EAN:	4250236821641
Customs Tariff No.	8501109990

DRAWING

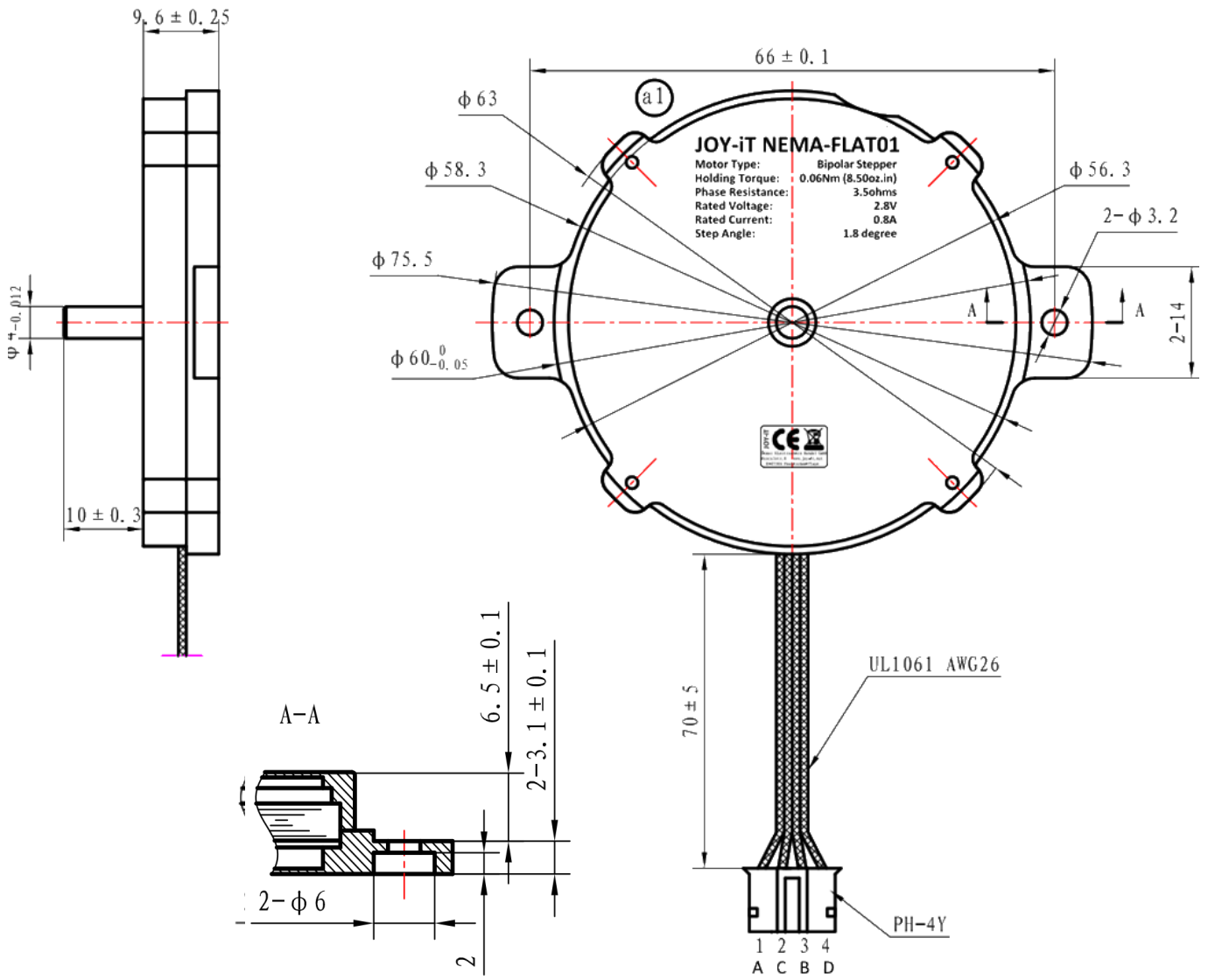

WIRING

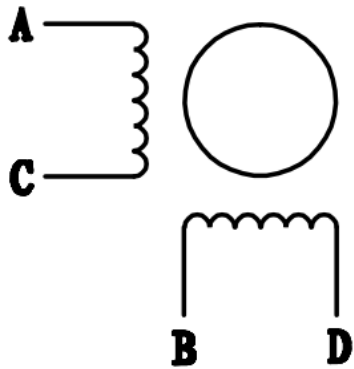

TORQUE DIAGRAM

42 DRIVER SETTINGS

Voltage 24,63 V

max. current 0,8 A

T(mN.m)

60

54

48

42

36

30

24

18

12

6

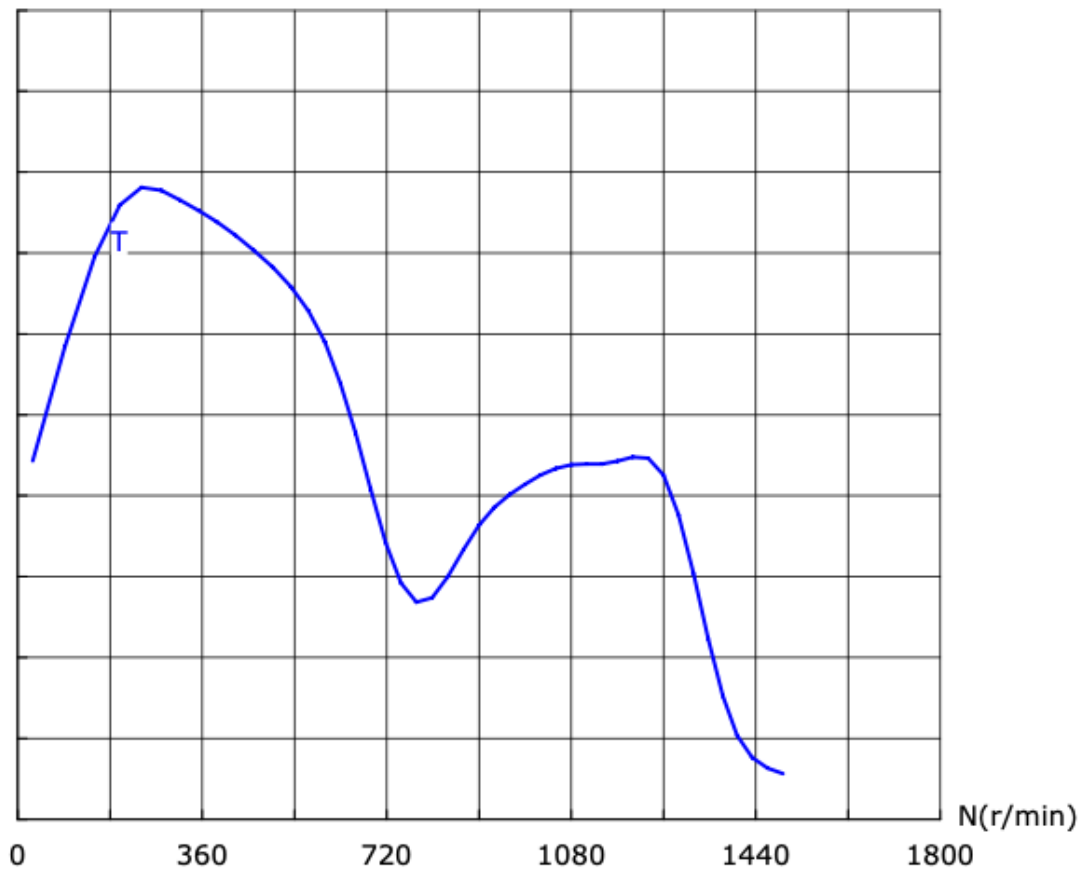

MAX. EFFICIENCY

Efficiency 24,8 %

Torque 26,8 mNm

Current 0,576 A

Speed 1230 min⁻¹

Output power 3,446 W

MAX. TORQUE

Torque 46,9 mNm

Current 0,406 A

Speed 241 min⁻¹

Output power 1,194 W

MAX. POWER

Torque 26,8 mNm

Current 0,576 A

Speed 1230 min⁻¹

Output power 3,446 W

Published: 21.10.2022